

SCIENCE IMAGING SYSTEMS

Application Note No. 8

LAS-1000 Features in Chemiluminescence Detection

LAS-1000

Introduction

The Fujifilm LAS-1000 Luminescence Image Analyzer, the chemiluminescence detection system from Fuji Photo Film Co., Ltd., incorporates a striking array of leading-edge technologies. Of particular note is an optical system that achieves outstanding sensitivity through a combination of a newly developed CCD sensor and a large-aperture camera lens. By providing 1.3-million-pixel, high-resolution image with 14-bit gradation, the new CCD camera makes the LAS-1000 a powerful tool for chemiluminescence image analysis. To get better image, the LAS-1000 further includes a feature that automatically corrects for differences in exposure to luminescent light between outer and center regions of the image.

This Application Note looks mainly at the LAS-1000 hardware, with the focus on structure, functions, special features and quantitation correction method. Tips on how to obtain better images are also presented, while following the image-taking process from warmup to shutdown.

Contents

1. Basic Features
2. Image Analysis with the Camera System
: A Problem and a Solution
3. The Tips to Better Images
4. References

Summary

- High sensitivity is achieved by the combination of newly developed CCD sensor and lens.
- Long exposure at low noise is enabled by cooling system, slow scan system and focal-plane mechanical shutter.
- A few simple operations can minimize the effect of optical shading error.

1 Basic Features

(1) High sensitivity

The LAS-1000 is equipped with a high-resolution, high-sensitivity CCD sensor and a large-aperture camera lens. This combination provides a high-sensitivity camera system that enables easy imaging of weak chemiluminescence.

■ CCD

The heart of the LAS-1000 is a newly developed CCD sensor with specifications of over-one-inch size, 1.3 million pixels, and 4-digit dynamic range and linearity. Each element or photo pixel of the CCD sensor is fitted with a microlens - a condenser lens of micrometer proportions - that helps to collect more light on to the pixels. The adoption of an interline type CCD sensor ensures high-quality images with little smear while simultaneously providing real-time-like focusing function.

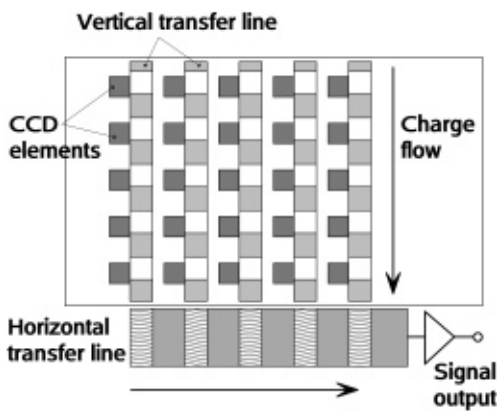

Fig.1-1

■ Camera lens

A large-aperture, high-sensitivity lens, the URF20L, has been made to further enhance the performance of the high-sensitivity CCD camera. With an f-number of 0.85, this is an extremely bright lens. Unlike the ordinary camera lens, it is specially designed to provide optimum performance at short distances (some tens of centimeters).



Fig.1-2

Over-one-inch

CCD sensor size is expressed as the diagonal length of the light-receiving surface. Since the EIAJ standard defines the size of a 16-mm movie projector camera lens as 1-inch, other diagonal sizes are expressed as 2/3 inch for 11 mm and 1/2 inch for 8 mm, respectively.

Smear

The tailing of bright pixels across an image in a particular direction. Smear occurs when an image with extremely high contrast exists on the CCD sensor, because electrons generated at bright portions tend to spill over to adjacent photo pixels.

Fig.1-1 Interline CCD sensor

This is a type of CCD sensor in which the sensor elements (photo pixels) and the transfer elements operate independently. The sensor elements and the transfer elements are formed side by side. The charges pooled in each sensor element are transferred to the neighboring transfer element and then from one transfer element to the next along the transfer line. Very short exposure becomes possible when the two types of elements operate independently.

f-number

An index of the brightness formed by a lens. The smaller the number, the brighter the image. The f-number of a lens is obtained by dividing its effective aperture by its focal length.

Fig.1-2 URF20L lens

(2) Low noise, long exposure

A CCD sensor cooling system, slow-scan system and mechanical shutter provide the LAS-1000 with low-noise, long-exposure capability.

■ Cooling system

The cooling system centers on a new Peltier element. The ability of the LAS-1000 to produce low-noise images even at long exposure times is made by cooling the CCD sensor to -30°C. Since this cooling reduces CCD sensor dark current to almost nil, the sensor's ability to pool charges generated by faint chemiluminescence emission is enhanced.

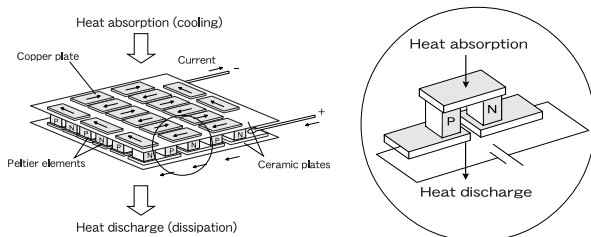

Fig.1-3

Low noise images obtained with the LAS-1000 can be easily processed into high-quality images after dark-frame subtraction.

■ Slow-scan system

The LAS-1000 is equipped with a slow-scan system that optimizes image quality. CCD camera can be classified to two types, in terms of read-out speed. Fast-scan is used for taking moving pictures to produce real-time images. Slow-scan is used for scientific measurement, which read-out slowly so as to minimize noise. In the LAS-1000, focusing performance is obtained by operating the CCD sensor read-out rapidly, while imaging of weak light is conducted by reading the stored image information slowly to preserve image quality.

Movie camera

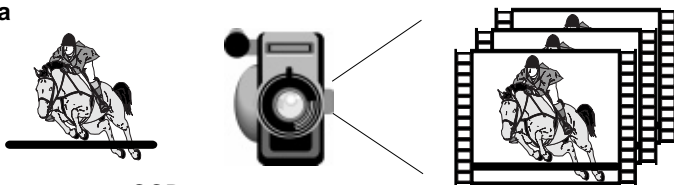

Scientific measurement CCD sensor

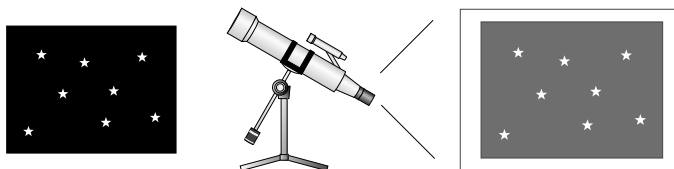

Fig.1-4

■ Focal-plane mechanical shutter

Focal-plane shutter is controlling the exposure time by sliding two shutter blades with a certain time lag. An advantage of this shutter is to get uniform exposure of the image. The LAS-1000 adopts a focal-plane shutter driven by a small pulse motor to enable precise exposure between as short as 1/100 second up to as long as 3,600 seconds.

Dark current

Heat-produced current that flows and causes accumulation of noise charges even in the absence of light. During long exposure, this noise becomes too large to be ignored. Since dark current is a function of temperature and exposure time, it is effectively reduced by cooling the CCD sensor.

Fig.1-3 Peltier element

Also called a thermionic element or thermomodule. When current is passed through a pn-junction semiconductor device, a temperature difference occurs between the opposite ends of the device. The Peltier element uses this phenomenon to for cooling. The semiconductor devices are usually series connected in a two-dimensional array.

Dark frame

An image frame produced solely by dark current, obtained by conducting an image-taking operation in the absence of light, with the mechanical shutter closed. The LAS-1000 automatically takes a dark image when instructed. A dark frame used for image correction has to be taken at the same temperature and exposure time as the image to be corrected.

Fig.1-4 Fast- and Slow-scan systems

A movie camera takes around 25-30 frames per second. (Fast-scan system)

A camera used for scientific measurement may have exposure times of several seconds up to several hours per frame. (Slow-scan system)

2 Image Analysis with the Camera System: A Problem and a Solution

(1) Problem

Like all camera systems, the LAS-1000 suffers shading error. This means that the center of an image formed through the camera lens receives more light than the edge, even when the imaged object is emitting the same amount of luminescent light across the image. The image quality is also affected by dust on the lens and other optical system elements, and also slightly by local differences in the sensitivity of the CCD sensor. Shading error correction is therefore necessary for accurate analysis of the images the system takes.

Shading error

Shading error makes an image taken with a wide-open lens brighter in the center than at the edges. For lenses with the same focal length, the effect increases with decreasing f-number (increasing brightness). Limb darkening can be substantially alleviated by closing the lens 2 or 3 f-stops, in a tradeoff with brightness.

(2) Solution

An image taken by the CCD camera should be processed by the following steps into a corrected image usable for image analysis

1) Take an image of the object.

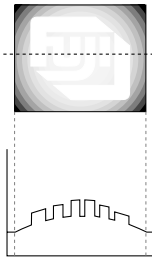

2) Take a dark frame using the same settings as in 1).

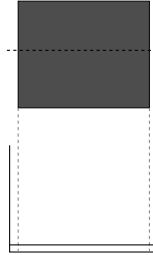

3) Subtract the dark frame from the object image.

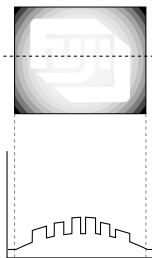

4) Take an image of a uniform surface light source and subtract a dark frame taken under the same exposure conditions from the surface image.

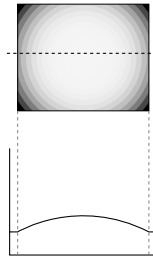

5) Divide the result of 3) by the result of 4).

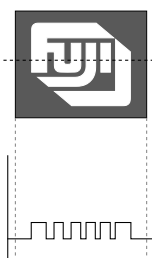

The corrected image should have the same luminescent light energy distribution of the original sample.

The general correction formula is :

$$F_c = (F_r - F_d) / (F_f - F_d)$$

F_c = Corrected image

F_r = Original image

F_f = Uniform surface light source image

F_d = Dark frame

For high precision in this correction, the image capture system must have wide dynamic range and linearity. The LAS-1000 system has 4-digit dynamic range and linearity, which is suitable for this purpose.

Since the LAS-1000 is preset with correction data (only for designated lenses) for applications based on the chemiluminescent method (Reference 2.), it can automatically effect correction in response to the selected image-taking distance and aperture settings, even though it is not equipped with a dedicated light source for correction.

3 The Tips to Better Images

Good image analysis depends on good imaging practices. Better image enables us to perform better image analysis. There are a few key checking points to get good image.

■ Warmup

The LAS-1000 warms up within 10 minutes after power-on. Use this time to start the computer and bring up the program. Also visually inspect the camera and surroundings, especially to confirm that the lens and sample tray are clean and that lens is not fitted with a filter.

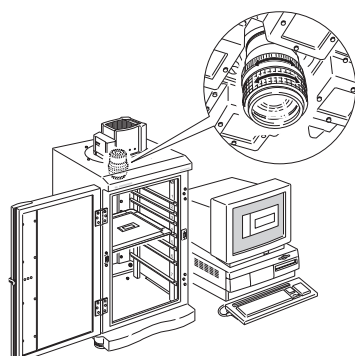

Fig.3-1

■ Setting sample tray

The LAS-1000 has seven sample tray settings. Place the sample in the center of the tray and change the read-out program mode to "Focusing." With an eye on the focusing monitor, determine the tray slot at which the sample occupies 80% of the image area.

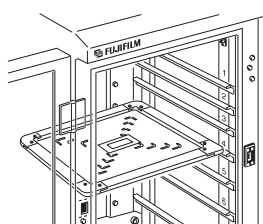

Fig.3-2

■ Focusing

The most important aspect of camera imaging is to focus properly. Since focusing precision is affected by depth of field, always focus the LAS-1000 with the iris wide open (set at $f/0.85$ when using the URF20L). In the chemiluminescence method, since the sample is usually a membrane filter, the focus can be conveniently checked with a piece of printed paper, placed on the tray.

Lens filter

In chemiluminescent imaging, remove all lens filters. If a filter for the fluorescent method is left on, it will cut the chemiluminescence spectrum and make chemiluminescent detection impossible (though it is absolutely necessary for fluorescent imaging).

Depth of field

The smaller the opening of the lens is, the larger the distance between the nearest and farthest points from the lens that are acceptably sharp. Be careful when the lens opening is small, the image is dark.

When the lens is wide open, the focus is sharp only within a very small range. This makes precise focusing easier.

The diagram below shows point A properly focused at point A'.

With lens wide-open

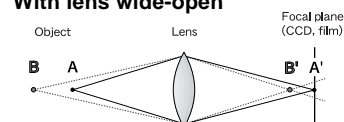

Point B is focused in front of the focal plane. At the focal plane, therefore, only point A is in sharp focus and point B looks blurred.

With iris stopped down

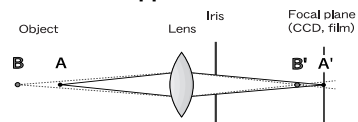

Although point B is still focused closer to the lens than point A, it is much less spread out (blurred) at the focal plane than when the lens was wide open.

The eye therefore sees both points A and B to be acceptably in focus at the focal plane.

In the case of points closer to the lens than point A, the situation is similar but the focal point falls behind the focal plane (right of the focal plane in the diagrams).

■ Setting the exposure time

When using its high-sensitivity lens (URF20L), the LAS-1000 can take image faster than is possible with film. Still, grainy image comes out if the exposure does not provide enough luminescent light. When image quality is particularly important, set the exposure time longer to let in more light. In applications not requiring observation of motion, long exposure is the key to accurate imaging. Exposure time of several minutes to several hours is possible with LAS-1000.

■ Shutting down

Following the prescribed shutdown procedures is important for ensuring good image quality the next time. After closing the computer program according to the manual, turn off the camera controller switch. Shutting down properly also helps to keep the LAS-1000 in top condition.

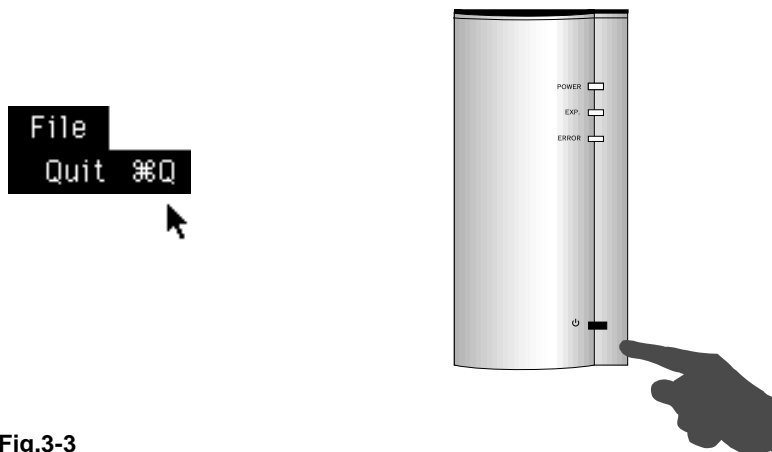

Fig.3-3

4 References

1. Blouke, M. M., Charge-Coupled Devices and Solid State Optical Sensors, *SPIE* ; Vol.1242, (1990)
2. Karger, A. E., et al., Digital chemiluminescence imaging of DNA sequencing blots using a charge-coupled device camera, *Nucleic Acids Research* ;Vol.20,No.24, 6657-6665 (1992)

Editors & Writers
Kenji Miura, Ph.D.
Seishi Ikami
Makiko Nagashima
Chiori Imai
(Fuji Photo Film Co., Ltd.)
March 1998



FUJI PHOTO FILM CO., LTD.
SCIENCE SYSTEMS, EQUIPMENT PRODUCT DIVISION
26-30, NISIAZABU 2-CHOME, MINATO-KU, TOKYO 106-8620, JAPAN
Telephone: +81-3-3406-2201
Facsimile: +81-3-3406-2158
E-mail: sginfo@tokyo.fujifilm.co.jp

©1997-1998 Fuji Photo Film Co., Ltd.